

NOTES:

- 1.) FRAME MATERIAL SHALL BE HOT ROLLED STEEL.
- 2.) COMPLETE UNIT SHALL BE HOT DIP GALVANIZED PER A.S.T.M. 123 AFTER FABRICATION.
- 3.) GRATES ARE DESIGNED FOR AASHTO H-20 WHEEL LOADS.
- 4.) EACH UNIT SHALL BE FABRICATED PER N.Y.S. STANDARD SHEETS.

SECTION B - B

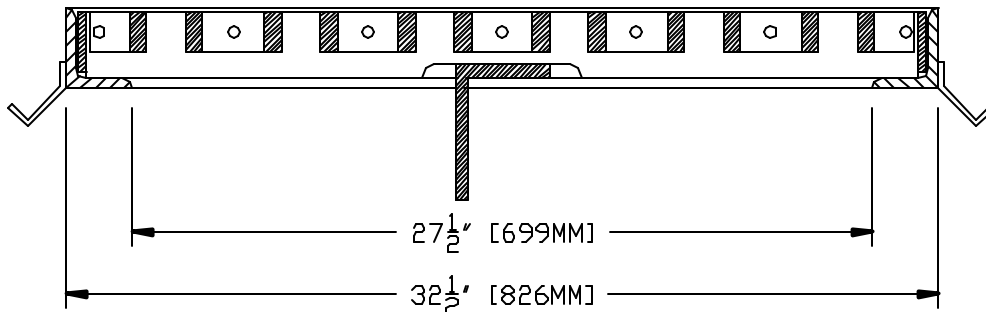

SECTION A - A

THIS DOCUMENT IS THE PROPRIETARY PROPERTY OF SYRACUSE CASTINGS. IT HAS BEEN FURNISHED UPON THE CONDITION THAT IT SHALL NOT BE RELEASED, DUPLICATED, USED, OR DISCLOSED IN WHOLE OR IN PART FOR ANY PURPOSE WITHOUT THE EXPRESS WRITTEN PERMISSION OF SYRACUSE CASTINGS AND SHALL BE CONSIDERED CONFIDENTIAL INFORMATION.

NYSDOT #2 Galvanized Steel
Reticuline Frame & Grate

DRAWING # #2F-#2 655-3

Drawn By: TJM

DATE: 8/3/09

Revised By:

Revised:



Syracuse Castings

Better By Design

P.O. Box 1821
6177 South Bay Rd.
Cicero, N.Y. 13039

Phone # 315-699-2601 Fax # 315-699-2982 www.syracast.com