

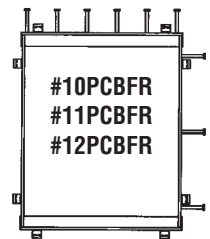

State of New York Department of Transportation
Parallel Bar Type Frame & Grate

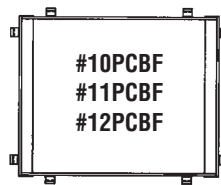
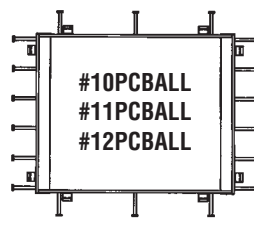
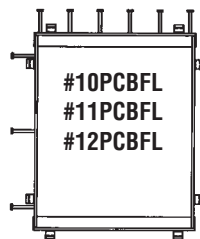
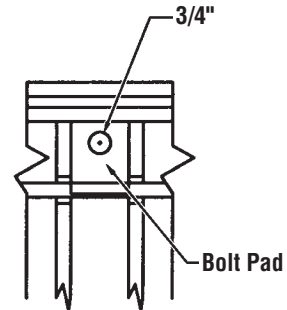
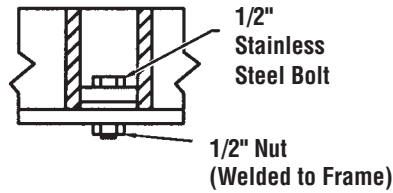
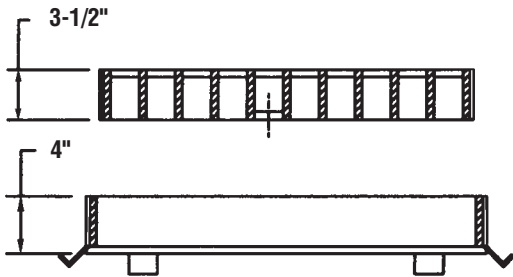
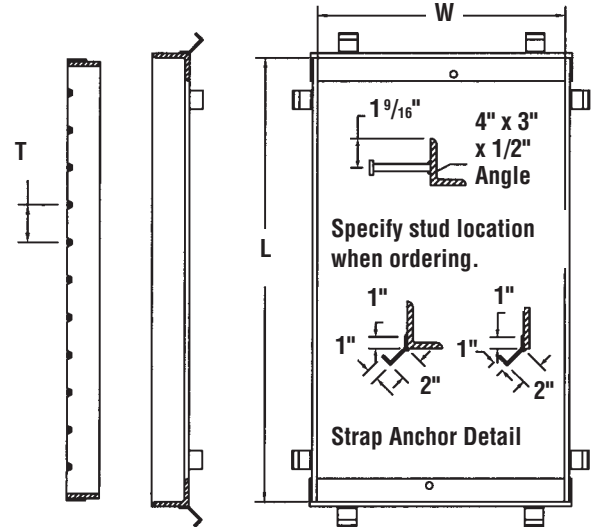
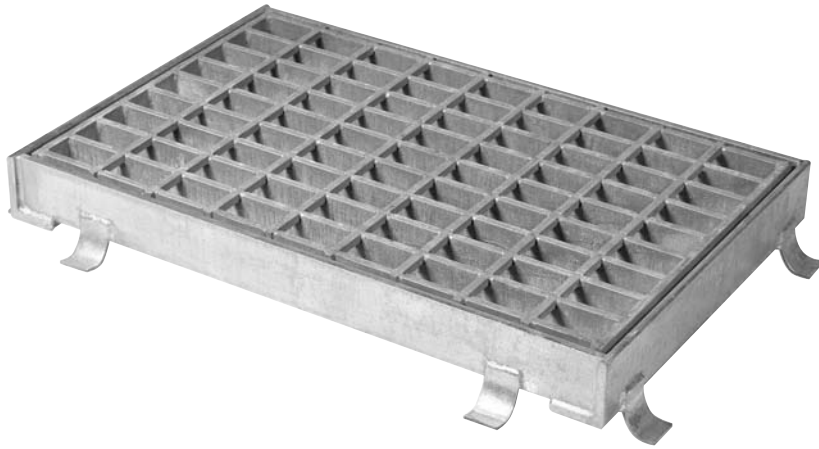

Grate Number	W	L	T	Number of Bearing Bars	Number of Cross Bars	Approx. Wt.	Payment Area in Sq. Ft.	Payment Area in Sq. M.
10 PCB	1'-11 1/2"	3'-0 3/4"	4"	10	8	200	6.2	0.58
11 PCB	2'-2"	3'-10 3/4"	3 3/4"	11	11	280	8.7	0.81
12 PCB	2'-9 1/2"	3'-5 3/4"	3 3/4"	14	10	320	10	0.93