

NOTES:

- 1.) MATERIAL SHALL BE GRAY CAST IRON CONFORMING TO A.S.T.M. A48 (LATEST REVISION) CLASS 30B.
- 2.) UNITS DESIGNED HEAVY DUTY FOR A.A.S.H.T.O. HS20-44 WHEEL LOADS.
- 3.) EACH FRAME AND COVER SHALL HAVE MACHINED HORIZONTAL BEARING SURFACES..

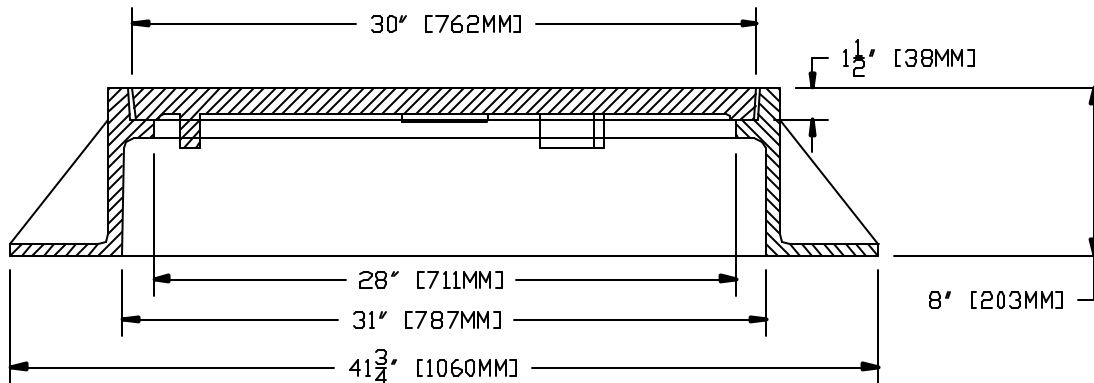

SECTION A - A

THIS DOCUMENT IS THE PROPRIETARY PROPERTY OF SYRACUSE CASTINGS. IT HAS BEEN FURNISHED UPON THE CONDITION THAT IT SHALL NOT BE RELEASED, DUPLICATED, USED, OR DISCLOSED IN WHOLE OR IN PART FOR ANY PURPOSE WITHOUT THE EXPRESS WRITTEN PERMISSION OF SYRACUSE CASTINGS AND SHALL BE CONSIDERED CONFIDENTIAL INFORMATION.

Pattern 1061 Cast Iron
Square Flange Frame & Cover

DRAWING # 1061499C-1011654PC

Drawn By: TJM

DATE: 7/20/09

Revised By:

Revised:



Syracuse Castings
Better By Design

P.O. Box 1821
6177 South Bay Rd.
Cicero, N.Y. 13039

Phone # 315-699-2601 Fax # 315-699-2982 www.syracast.com